

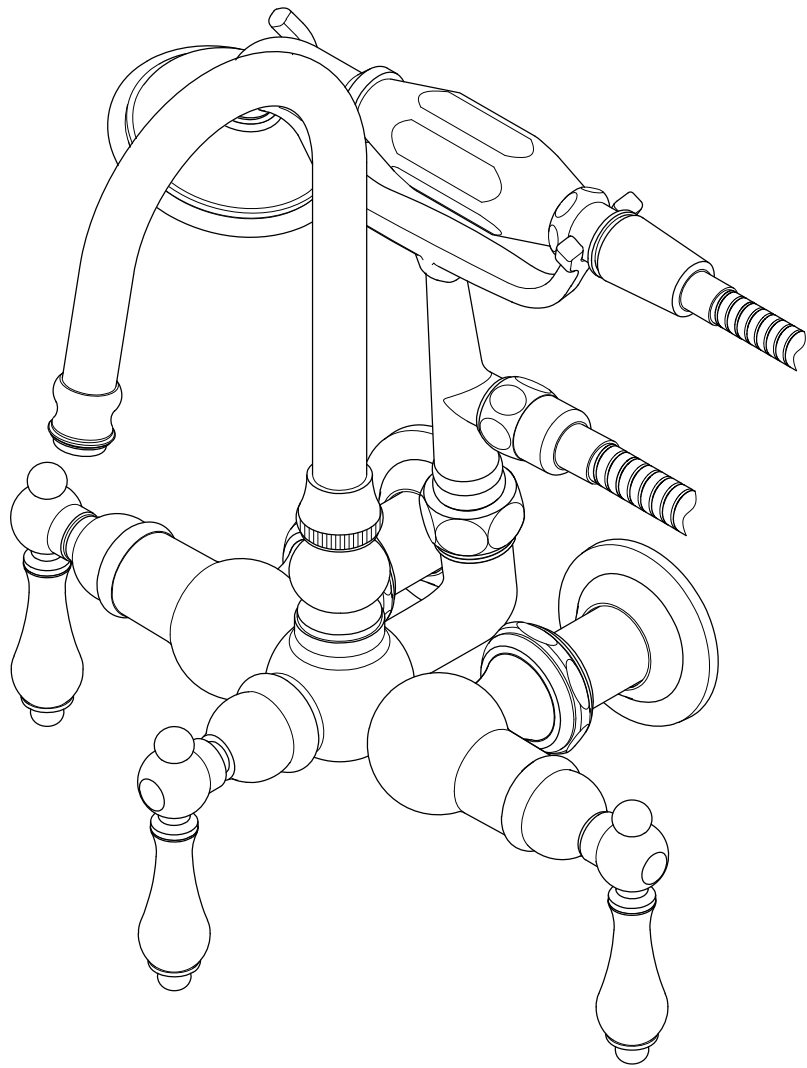

JETSTREAM WORKS

EDWARDIAN

Wall Mount Tub Filler with Hand Shower



Parts:

Lock Nut

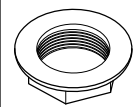

2 Pcs

NOTICE
Failure to follow all directions may cause leaks
which may result in water damage



JETSTREAM WORKS

EDWARDIAN

Wall Mount Tub Filler with Hand Shower

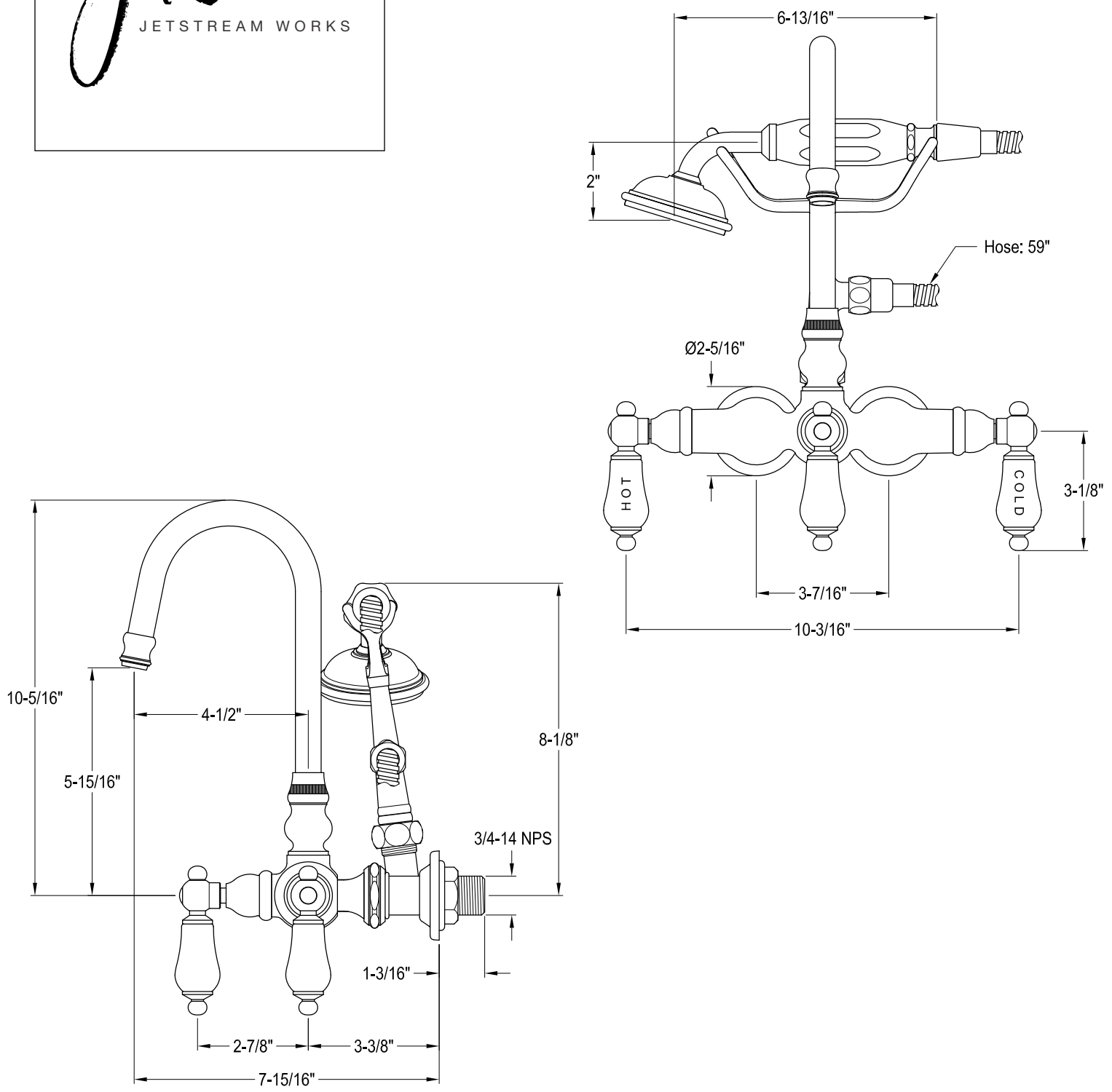



EDWARDIAN

Wall Mount Tub Filler with Hand Shower

CARE AND MAINTENANCE OF YOUR FAUCET

Your Jetstreamworks faucet has been finished to the most strict standards; however, due to the high content of minerals in the water, your finish may appear dull and tarnished after time. These are some do's and don'ts to maintain the luster on your faucet for many years to come.

- DO**
1. Use a silicon based caulking when installing.
 2. Clean your faucet with only a mild soap and water solution.
 3. Dry your faucet after using it.
 4. Give it a coat of Carnauba Wax periodically.

- DON'T**
1. Use plumbers putty when installing the faucet.
 2. Use any abrasive cleaning agents.



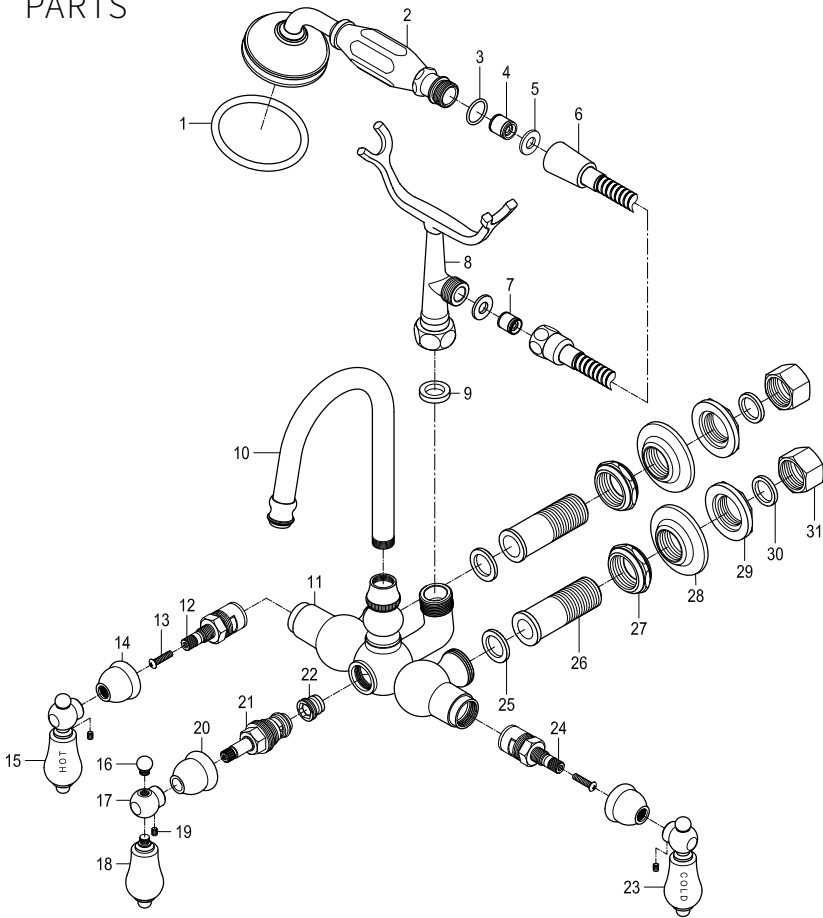

It may seem like a very simple and short list but it is that simple to maintain your faucet, looking shiny and new.

If your faucet is already looking somewhat dull and tarnished, before replacing it, try cleaning it with a 50/50 solution of vinegar and water, you may need to soak some rags and wrap around those stubborn areas, leave overnight and rinse completely in the morning, apply Carnauba wax once you have removed the mineral deposits.

PARTS

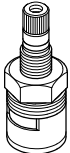
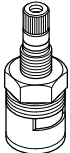
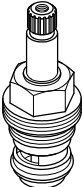

Replacement Parts:

Hot Cartridge KSRPT1000HC	Cold Cartridge KSRPT1000CC	Diverter Cartridge KSRPT1000DC	Hot Handle CCPL1H	Cold Handle CCPL1C	Diverter Handle CCPL1
					

INSTALLATION INSTRUCTIONS

NEED TOOLS

BEFORE BEGINNING INSTALLATION:

1. Flush plumbing lines to clear any debris.
2. Shut off both supply lines after flushing.

Basin Wrench

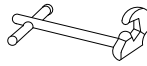

Adjustable Wrench

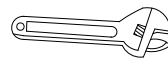

Teflon Tape



Silicone Sealant

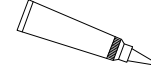

Screwdriver

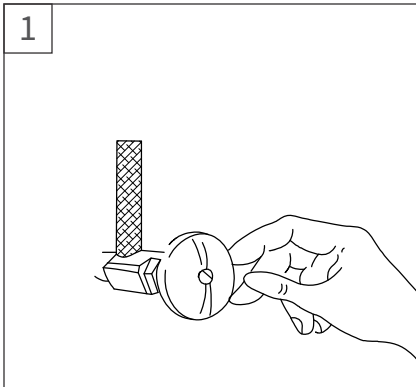
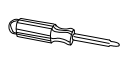

Shut off main water supply valve before installation.

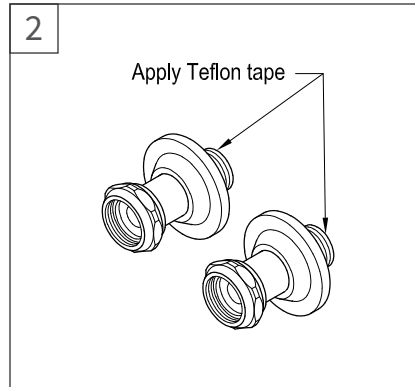

Apply Teflon tape on the threads of the copper shank. Install the elbow.

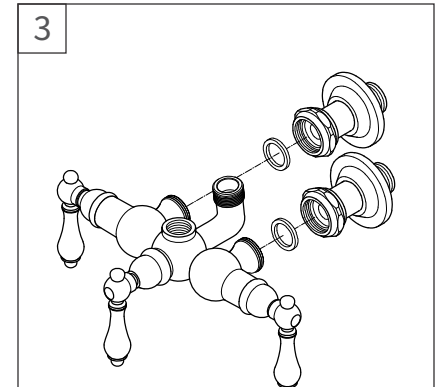

Before mounting the faucet onto supply elbows, apply small black washers onto both water inlets of faucet.

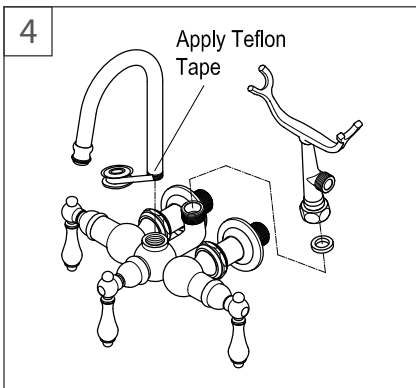

Apply Teflon tape on the threads of the spout shank. Install the shower cradle and spout on top of faucet body.

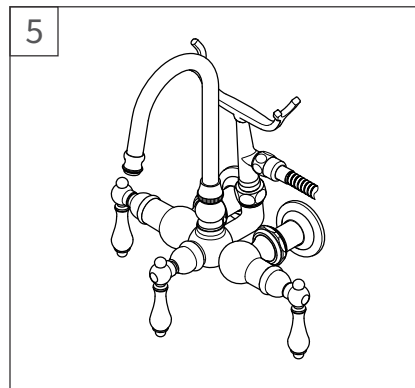

Place a washer between the side hole of the shower cradle and the cone nut of the shower hose. Tighten the cone nut.

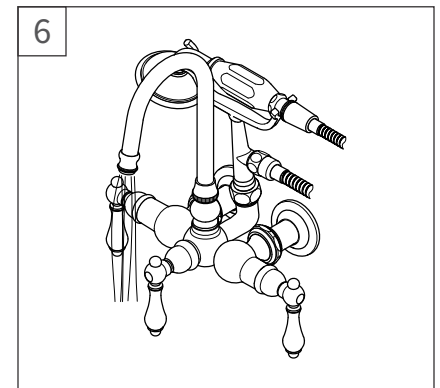

Turn on the faucet and let hot and cold water to run for at least one minute to clean any debris inside the water line.

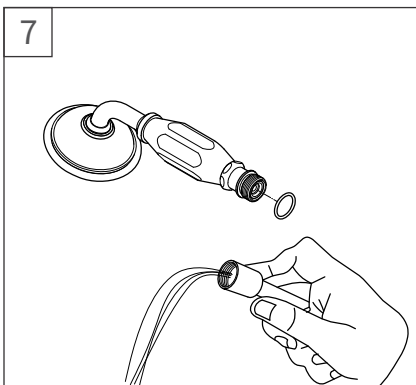

Remove shower by unscrewing the shower in a counter clockwise direction, turn on both hot and cold valves and let water run for at least one minute, this will clear any debris left in the line.

WARNING!!!

- DO NOT STEP ON faucet or supply line installation. This fixture is not a stair to access your storage, window or access higher ceiling. This Cast Brass Faucet cannot support your body weight. To step on faucet will crack the fitting and eventual fracture to cause water damage to your property.
- The faucet was tested and meets ASME/ANSI code on its operation, loading and torque pressure. However this faucet is not designed to support weight over 250 pound per square inch of pressure, DO NOT OVERTIGHTEN. DO NOT APPLY ELECTRICAL TOOL to fasten faucet installation.
- For Exposed tub supply line installation faucet model, your supply lines have to be installed on corner area, or at area with no walking traffic access to cause accidental tamper or accidental breakage. For installation of exposed supply line at open traffic area is prohibited.
- Removal of this tag prior to installation will void your warranty. Pass the WARNING TAG to the owner after installation.
- Do not over-tighten nut during installation.
- Over-tighten may crack the valve and cause severe leak.